

FLUX

user
manual

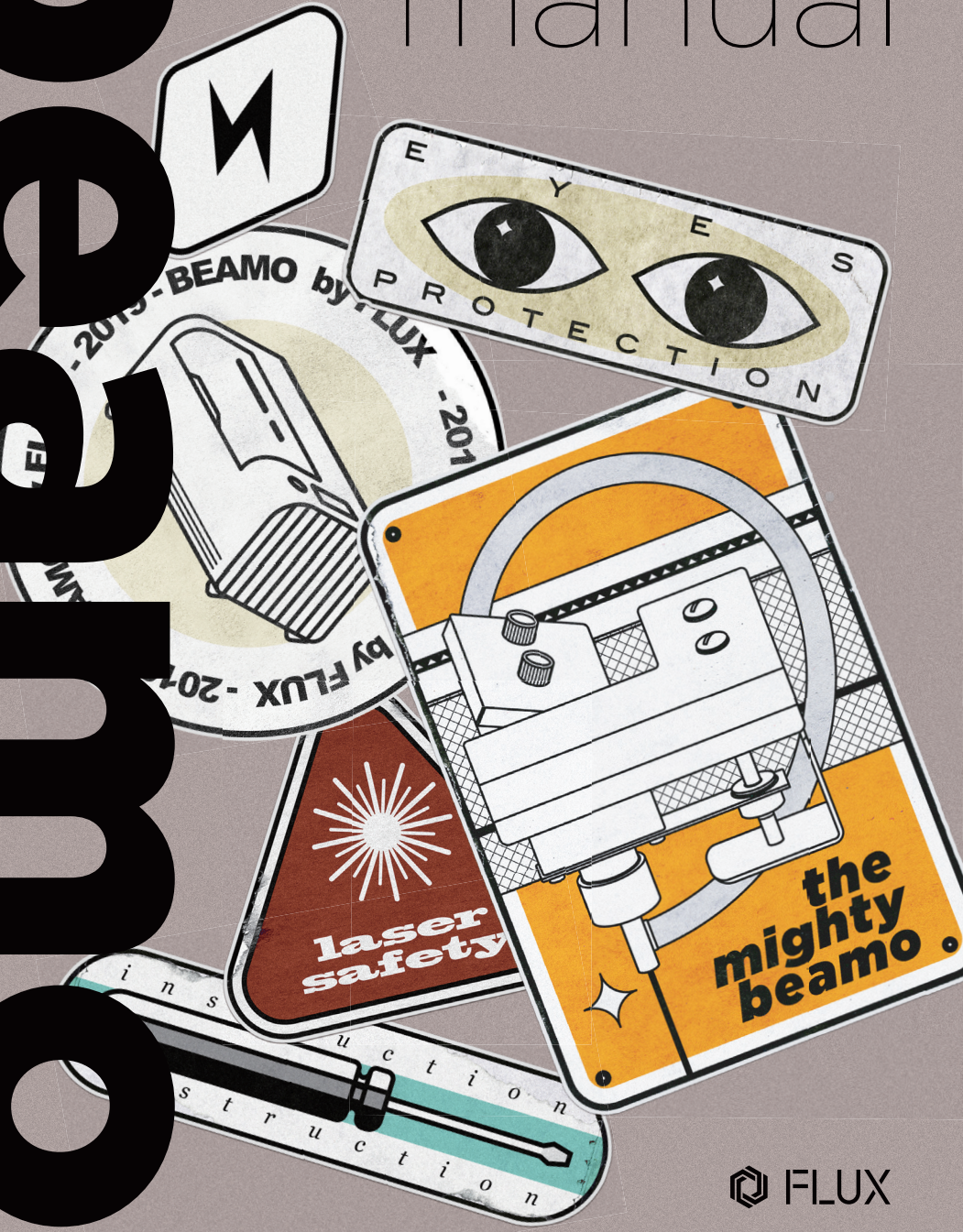

WELCOME TO THE FLUX COMMUNITY!

FLUX started with a passion for digital creation and making easy-to-use and affordable tools for makers and designers. 2,500 backers helped us successfully raise \$1.6M on Kickstarter for our first modular 3D printer, FLUX Delta, back in 2014. Having received numerous requests from our users for a more accessible laser cutter, we decided to take on this challenge and dove into the world of laser technology. In the last couple of months we have worked hard for this moment and put a lot of heart and soul into development and production.

We proudly present **beamo**, the laser cutter that will help you create things that you'll love, and have fun during the process, too. With the hashtag **#madewithbeamo**, you will find inspiration from other members of the FLUX Community. Please share your creations online with us, we can't wait to see how you will use your beamo and all the amazing things you will make!

In pursuit of the same goal we've had since day one, we work closely with our users. So please do not hesitate to contact us, we are looking forward to your feedback. You can always reach us at support@flux3dp.com.

Enjoy!

Team FLUX

TABLE OF CONTENTS

Welcome

1.1 Using This User Manual.....	09
1.2 CO2 Laser Basics.....	10
1.3 Safety & Conformity.....	12

Unboxing

2.1 What's In The Box.....	17
2.2 Assembly.....	20
2.3 Network Setup.....	21
2.4 Software Download & Setup.....	22
2.5 First Task.....	24

Software Beam Studio

3.1 Software User Interface.....	29
3.2 Touch Screen User Interface.....	32
3.3 Bitmap Engraving.....	33
3.4 Vector Engraving.....	34
3.5 Comparison Between Bitmap & Vector Format.....	35
3.6 Layer Setting.....	35
3.7 Save Scene.....	35
3.8 Recommended Design Software.....	36
3.9 Smart Trace.....	37

TABLE OF CONTENTS

Material Technique

4.1 Testing New Material.....	41
4.2 Wood.....	42
4.3 Leather.....	43
4.4 Acrylic.....	44
4.5 Paper.....	45
4.6 Glass.....	46
4.7 Metal.....	46
4.8 Other Safe Material.....	47
4.9 Dangerous Material.....	47

Project Ideas.....	50
---------------------------	-----------

Maintenance & Care

6.1 Keep Everything Lubricated.....	52
6.2 Cleaning Of The Workarea.....	53
6.3 Wiping The Lens.....	54
6.4 Water Cooler Maintenance.....	56
6.5 Optical Path Alignment.....	59
6.6 Laser Tube Replacement.....	73

TABLE OF CONTENTS

Troubleshooting

7.1 No Laser Beam Output.....	85
7.2 Cut Did Not Go Through Material.....	86
7.3 #900 Cooler Off.....	86
7.4 #901 Door Opened.....	87
7.5 #902 Overheated.....	88
7.6 Laser Head Did Not Return To Rear Left Corner.....	88
7.7 Camera Alignment Issue.....	89
7.8 Camera Preview Speed Too Slow.....	89
7.9 Camera Preview Does Not Work.....	90
7.10 Connection Issue.....	90
7.11 Software Quits Unexpectedly.....	94

Additional Information

8.1 Technical Data.....	96
8.2 Storage and Transport.....	96
8.3 FLUX Support.....	97
8.4 Disassembling & Dismantling.....	97

**W E L
C O M
E**

1.1 USING THIS USER MANUAL

These operating instructions must be carefully read and observed before using beamo for the first time. Non-observance of individually listed points in the instructions can cause personal injury and/or property damage.

No part of this manual may be reproduced, edited or modified in any form without the prior consent of FLUX Inc.. The rights for reproduction in any form are reserved. FLUX Inc. reserves the right to change specifications of the hardware and software described in the user manual at any time and without prior notice.

The following symbols are used to facilitate the understanding of this manual:

 *Warning:* This area represents a special danger for the user or the person responsible for maintenance if the operating instructions are not observed.

 *Warning:* In these areas, pay particular attention to the possible dangers of laser light.

Additional accessories must be compatible with the base unit (if you have any questions, please contact FLUX Support: support@flux3dp.com).

Please keep this user manual for future reference.

1.2 CO2 LASER BASICS

The purpose of a laser cutter/engraver is to focus a high-power laser beam on the surface of a workpiece. The part of the workpiece which absorbs the high energy from the laser beam will burn or vaporize instantly, Enabling cutting or engraving along the work path of the laser beam.

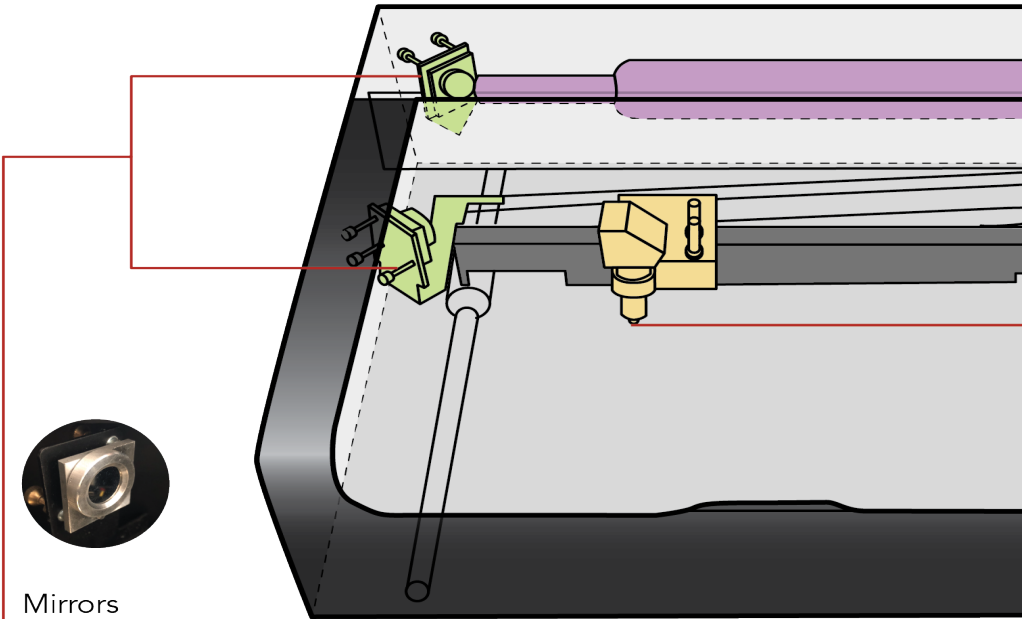

Mirrors

There are three mirrors inside the machine. The first mirror is in a fixed position, and the second and third mirrors are driven by motors to guide the laser beam to the right position in the work area. The second mirror moves back and forth to control the position of the Y-axis; the third mirror moves left and right to control the position of the X-axis.

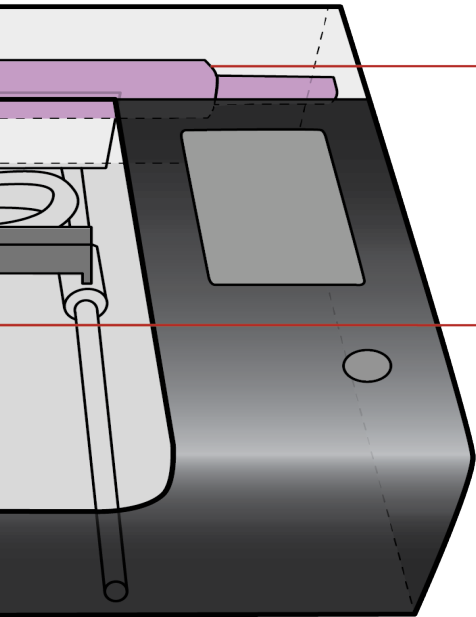

Laser

beamo is equipped with a 30W CO₂ laser. CO₂ gas is encapsulated in a glass tube. When a high voltage is applied across the laser tube, the gas is energized and produces an invisible laser beam with a wavelength of 10.6 μm. A parallel beam with a diameter of about 5 mm is emitted from the end of the tube. Due to low divergence, this parallel beam can be transmitted inside the machine with little loss of energy.



Focus Lens

After the third reflection, the laser beam will hit the surface of the work-piece directly. In order to achieve a higher energy density, the focus lens focuses this a parallel beam from about 5mm diameter to about 0.2mm. If the beam is properly focused, its energy is enough to burn through non-metallic materials such as wood and acrylic.

1.3 SAFETY & CONFORMITY

Be sure to read the following safety precautions carefully before starting to operate beamo. beamo uses a high-power laser beam. Improper handling can result in fire, visual impairment, skin burns, or inhalation of toxic substances, and other personal safety hazards.



Important Precautions

1. Never leave the machine unattended while operating.
2. Be sure to have a fire extinguisher in the work area.
3. Do not try to service, repair, or modify the machine without authorization from FLUX Support.
4. Do not stare at the flame generated by the laser.
5. Please make sure that the processed material does not pose a hazard when burned at high temperatures.

User Safety

1. All personnel who will operate the machine should read the safety precautions and follow the instructions. Confirm with FLUX Support if you have any questions regarding use and safety: support@flux3dp.com.
2. Children require the supervision and assistance of an adult at all times.

3. Operating environment:
 - a. Place the machine in a well-ventilated area.
 - b. Avoid rain, moisture, liquids, or direct sunlight.
 - c. The ambient temperature should be between 5°C and 35°C (41°F and 95°F), and humidity between 10% and 75%.
 - d. If venting outdoors, make sure that changing conditions do not cause extreme temperatures or humidity to affect the machine through the exhaust duct. Disconnect the duct from the outside air when the machine is not in use.
 - e. Place the machine on a stable surface to prevent it from moving or overturning.

Electrical Safety

1. The machine comes in 2 versions, 110V and 220V. Do not use a power source other than the AC rated voltage. If in doubt, contact FLUX Support. (110V: 100 - 127V / 220V: 200 - 240V)
2. Make sure that the grounding pin is properly connected. If not grounded properly, static electricity might be generated that could affect performance and even increase the risk of electric shock.
3. Do not use the power cord if it is damaged.
4. When maintaining or disassembling the machine with the consent of FLUX Support, be sure to turn the power off and unplug the unit.

Fire Safety

1. Do not put anything inside the machine that is not laser-compatible. Learn more about laser-compatible materials.
2. Do not stack materials; for example, do not attempt to cut two or more sheets of material at a time.
3. Clean out leftover debris inside the unit when it builds up.
4. Never leave the unit unattended while operating; always keep it within sight. Look inside frequently.
5. If there is a lasting flame inside the unit that does not extinguish after the laser has moved:
 - a. Turn off the machine and pull the plug on the back of the unit.
 - b. If it is safe to do so, extinguish the fire with a wet towel. Note that water may damage the machine.
 - c. Alternatively, extinguish the fire with a fire extinguisher. Note that fire extinguishers may damage the machine.
 - d. If the fire cannot be extinguished or if it spreads outside the machine, call your local emergency number.

Smoke and Fume Safety

1. When exhausting outdoors, be sure that the exhaust location won't be bothersome to neighbors or passers-by, and don't forget to check local air quality regulations that may apply.
2. If a strong, sharp smell -- that also causes eyes, nose, or throat irritation -- is detected, or visible smoke is escaping the machine while the lid is closed, stop immediately and re-

check your exhaust setup.

Operation Safety

1. Do not stare at the flame generated by the laser.
2. Stabilize the unit to prevent it from moving or overturning.
3. In case of burn injury, seek medical advice.
4. Wear gloves when cleaning leftover debris.
5. Have two people lift the unit when moving the machine.



Stop using your beamo if...

1. There is a fire in the unit which persists after the laser turns off.
2. The head stops moving but the laser is on.
3. An unusual sound or unusual light is coming from the unit.
4. You see any damage to the interior components of the unit.

Conformity

The beamo unit is a Class 1 laser product containing an embedded Class 4 CO2 laser and a Class 1 laser diode. Because the Class 4 laser is fully contained in a Class 1 enclosure, this laser product is designated as a Class 1 laser product during all procedures of operation.



U N
B O X
I N G

2.1 WHAT'S IN THE BOX

1. Place the box on the floor and open it.



2. Remove the packing foam on the four corners and take the machine out of the box. Have two people lift it out of the box. Keep the packaging in case you need to transport the machine in the future.



3. Open the lid and take out the vent hose, then take out the Accessory Kit.



4. Content of the Accessory Kit: : ① Wi-Fi dongle ② lubricant ③ duct clamp ④ double-sided tape ⑤ power cord ⑥ small wrenches ⑦ hex key ⑧ funnel ⑨ sample material



5. Front view: ① laser head ② focus bar ③ honeycomb plate ④ touchscreen ⑤ power button ⑥ transparent lid

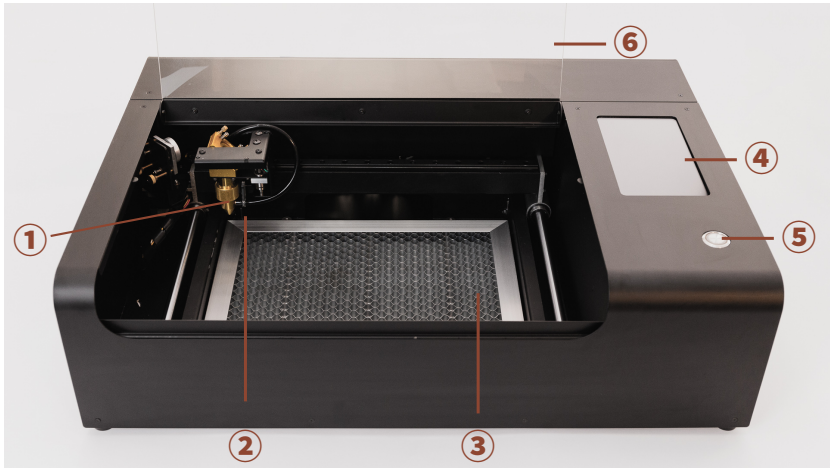

6. Rear view: ① USB ports ② Ethernet port ③ power connector ④ exhaust fan



2.2 ASSEMBLY

1. Connect the power cable.
2. Plug the Wi-Fi dongle into one of the two USB ports in the back of the machine. Turn the antenna upwards 90° for a better connection.



3. Use the duct provided. Slide the duct clamp around the bigger end of the duct then install the duct and clamp over the fan exhaust on the back of your beamo. Use the small wrench to tighten the clamp.



2.3 NETWORK SETUP

1. Press the power button to turn the machine on. It takes about 1 minute to start up.
2. On the touchscreen, tap on **Settings** > **Internet** > **Settings** then select a Wi-Fi network and enter its password.
3. An IP address indicates the machine is connected. Restart the machine when network setup is done.



2.4 SOFTWARE DOWNLOAD & SETUP

1. Download the latest version of “Beam Studio -- Stable” from the download section on the official FLUX website:

<https://flux3dp.com/downloads/>

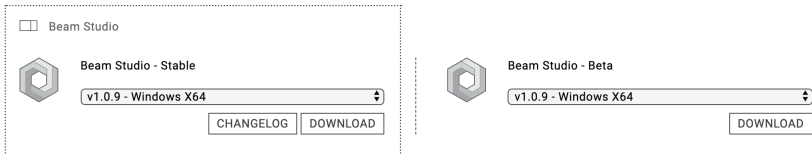

Windows: To check what version you need to download , right-click on the “This PC” icon > Properties and find “System type”. Download the x86 version for 32-bit systems and x64 version for 64-bit systems.

MacOS: Download and open the DMG file and drag the Beam Studio app into the Application folder next to it. Run the Beam Studio in the “Application” folder.

2. A language dialog will appear when running Beam Studio for the first time. Select English > FLUX beamo.

Troubleshooting: Software Unexpectedly Quits (p.94)

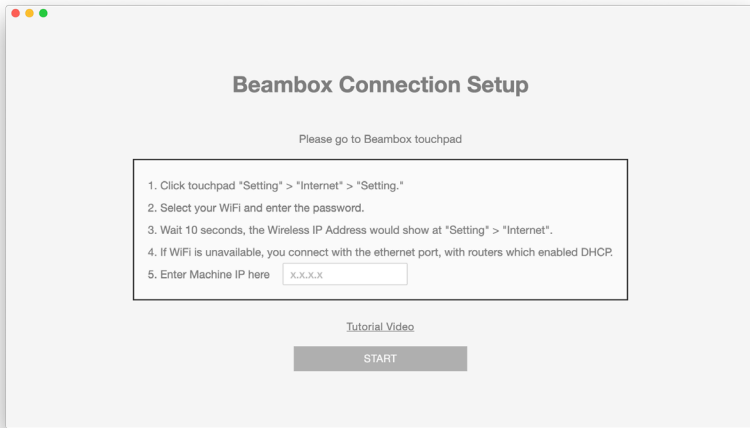

3. Fill in your beamo's IP address in the text box and click Start
4. Go to **menu > Machine** or click on the camera icon at the bottom left corner to check if your beamo's name can be found.

 If you accidentally skip this dialog, click **menu > Machine > Machine Setup**

Start your first task!

2.5 FIRST TASK

1. Adjusting Focus

Place a workpiece in the machine. Rotate the focus bar (acrylic bar) downward until it is vertical. Loosen the laser head focus ring and lower the laser head until the focus bar rests on the workpiece. Tighten the laser head focus ring, and rotate the focus bar upwards until it is horizontal.



▲ loosen the laser head focus ring

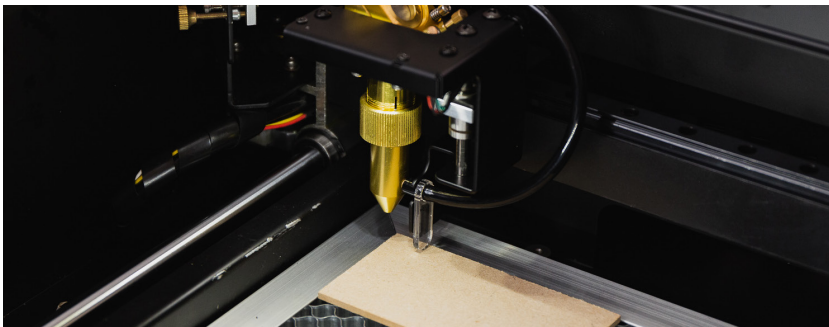

▲ the focus bar should rest on the workpiece

💡 The focus must be readjusted each time the material is changed.

2. Camera Preview

In Beam Studio, click on the camera icon (📷) at the bottom left and select your machine from the list. The preview mode is ready when the mouse cursor becomes a camera (📷). Click and drag your mouse cursor to preview the work area. Click on 📷 again or press ESC to leave preview mode.

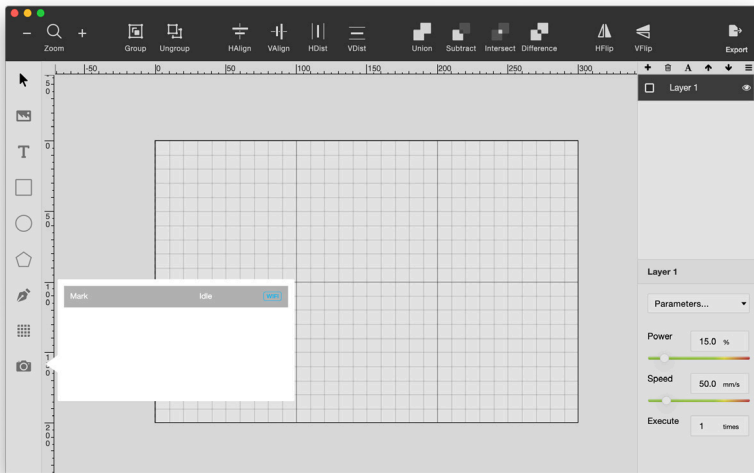

💡 If the preview result is not accurate, click **menu > Machine > choose Machine > Calibrate Camera** to run camera calibration. Compare the red-dotted-line square with the actual square engraved, manually adjust values to overlap the 2 squares.

2. Import Test File

Click on menu > File > Samples > Example of beamo.

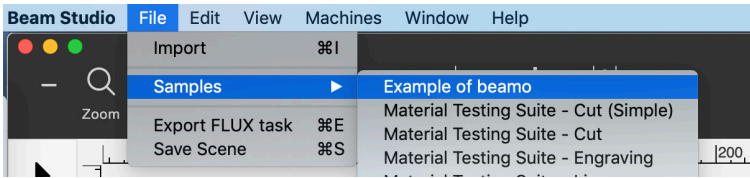

Place the image at the ideal spot.

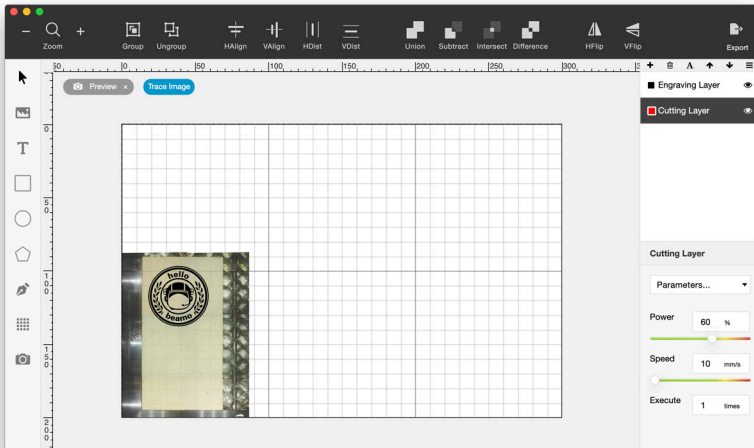

Click on **Export**, select your machine from the list, and click **Start** to start the task.

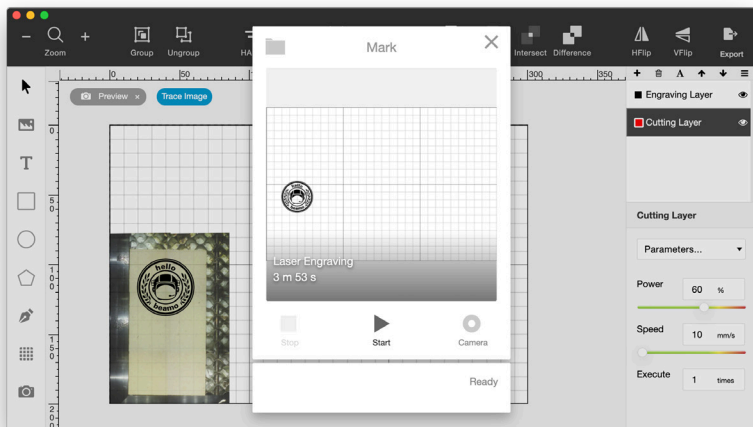

3. Test Result



If the result is too light or blurry, please check if the focus is just right. If the focus is right but the result is poor, please recheck the optical path. See “Optical Path Adjustment” (p.600000). If the position of the result varies with the camera preview, please recheck the focus or see “Camera Alignment Issue” (p.89).

**S O F T
W A R E**

B E A M

**S T U
D I O**

3.1 SOFTWARE USER INTERFACE

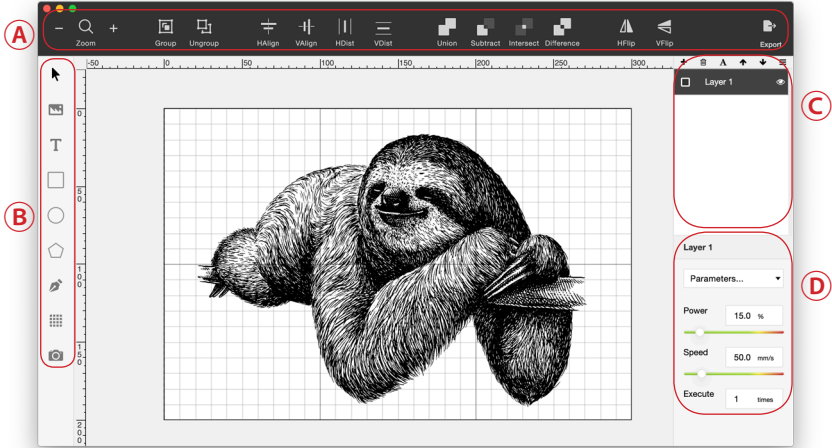

A. Object Placement

 : Zoom in and zoom out

 : Group multiple items together

 : Ungroup items

 : Align multiple items horizontally





 : Align multiple items vertically

 : Distribute selected items horizontally between the left and right borders









 : Distribute all selected items vertically between the top and bottom borders

 : Traces the outline of all objects as if they were a single, merged object

 : Subtracts the frontmost objects from the backmost object

-  : Traces the outline of the region overlapped by all the objects
-  : Traces all nonoverlapping areas of the objects, and makes overlapping areas transparent
-  : Reflect an object across a horizontal axis
-  : Reflect an object across a vertical axis
-  : Export the laser job to your beamo

B. Object Editing

-  : Selection tool
-  : Import JPG/PNG/SVG/DXF files. You can also drag the file into the software
- T** : Type tool
-  : Rectangle tool
-  : Oval tool
-  : Polygon tool
-  : Pen tool
-  : Copy selected objects into a rectangular array
-  : Enable / disable camera preview

C. Layer Management

- +** : Create and name a new layer
-  : Delete selected layer
- A** : Rename selected layer
- ↑↓**: Sequence arrangement, the working sequence will be from top to bottom

D. Power and Speed Setting

Parameters for commonly used material can be found in the "Parameters..." drop down list. Customized parameters can be set using "Save". Use "Manage" to edit or remove saved parameters. Power is set by percentage which means a 30W machine can output 30W if the power setting is 100%. Speed is set by mm per second. Execution count can be set to repeat the same action on a single layer.

 Parameters may vary with different materials. Try built-in parameters on first run and then fine tune the parameters for better results.

 The power setting is recommended to not exceed 70% to avoid drastic consumption of laser tube.

3.2 TOUCHSCREEN USER INTERFACE

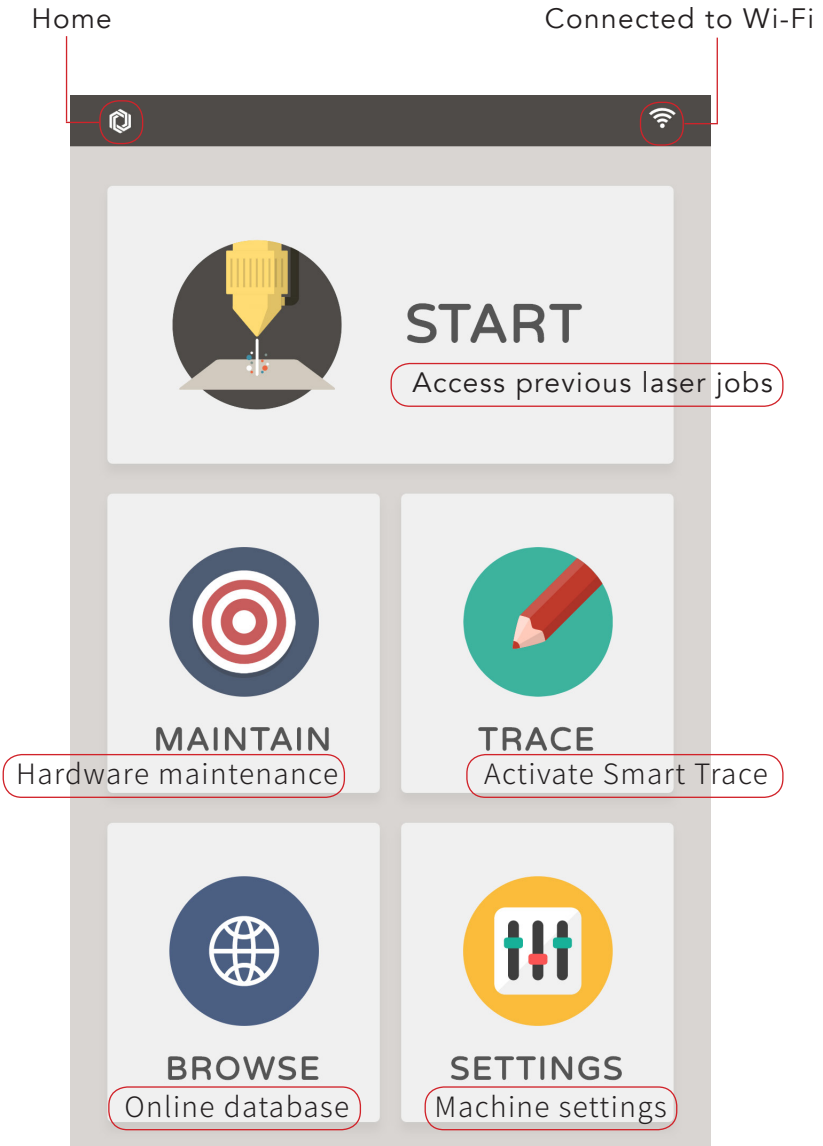

3.3 BITMAP ENGRAVING

Bitmap and vector are two different types of digital image files. Bitmap is an image type that consist of numerous square pixels. Bitmap files are rich in details which are mostly suitable for photography or digital applications. However, the quality is related to the resolution so the image can get jagged or blurry when resized. JPG and PNG are two commonly used bitmap format which are both compatible with Beam Studio.

Engraving Resolution

The Engraving resolution can be set in Beam Studio by menu > **Edit** > **Document Setting**. Engraving resolution stands for the fineness and quality of the result. You will get more detailed results when the resolution is set to "High", "Low" means shorter working times while getting a rougher quality. The quality stands for the spacing of each line scanned by the laser which correspond to 0.2mm /125 dpi, 0.1mm/250 dpi and 0.05mm/500 dpi.

Threshold

The exposure threshold value can be set when a bitmap image file is imported to Beam Studio. Find the "Shading" and "Threshold" option in the "Laser Config" label. When "Shading" is disabled, images will be transformed into

monochromic, which is optimized for built-in "Monochromatic Engraving" parameters. When "Shading" is enabled, images will be transformed into greyscale, which is optimized for built-in "Shading Engraving" parameters.

The "Threshold" value can be adjusted when "Shading" is disabled. This function is based on the RGB color model which defines colors from 1 to 255. 1 stands for black and 255 stands for white. For example, setting the threshold value to 125 will turn all colors above 125 into white.

3.4 VECTOR ENGRAVING

A vector image is composed of paths defined by multiple points. Each path, curve or polygon is constructed with its own formula which means the quality will not be affected when resizing the image. Vector images are especially suitable for logos and typesetting materials. Beam studio is compatible with SVG and DXF vector formats.

Layers is a good way to manage a complex artwork when creating a vector image. Take Adobe Illustrator for example, the design can be organized by either different color groups or different layers. Beam Studio can read the layer setting so different engraving parameters can be set for each layer. Cutting and engraving can be processed in the same time by this manner.

3.5 COMPARISON BETWEEN BITMAP AND VECTOR FORMAT

	Bitmap	Vector
Format	JPG / PNG	SVG / DXF
Usage	infill engraving (monochrome/shading)	outline engraving/ cutting

 Select vector format for all cutting jobs.

3.6 LAYER SETTING

You can set the layering style by "Layer", "Color" or "Single Layer" when importing a SVG file.

Layer: The layers will be categorized according to previous layer settings

Color: The layers will be categorized according to its color

Single Layer: Merge all layers into one single layer

3.7 SAVE SCENE

The "Save Scene" function can save all the items on the scene and keep them editable. This is useful when the design needs some editing but most of the scene should remain the same. Find this function in menu > "File" > "Save Scene".

3.8 RECOMMENDED DESIGN SOFTWARE

AutoCAD is a CAD software specialized in accurate dimensions, solids and more. Suitable for architecture and engineering applications. AutoCAD can export DXF format which is compatible with Beam Studio. If the dimensions do not match with the original design when imported, draw a 100mm square in Autocad then import it into Beam Studio to calculate the correct DPI.

Adobe Illustrator is a vector graphic design software which is suitable for publishing, website and other applications. Illustrator can export SVG format which is compatible with Beam Studio. Please select the SVG 1.0 format when exporting SVG files. Choose "Outline" for texts, "embed" for images.

Inkscape is a free and open source vector graphic design software. Its functions are similar to Illustrator. Inkscape can export SVG, JPG and PNG format which is compatible to Beam Studio. Please select "plain SVG" format when exporting SVG format.

3.9 SMART TRACE

Smart Trace in Beam Studio uses the onboard camera to scan and trace the outline of simple patterns. The process is quite simple, first you draw something on paper and the camera in beamo will convert your drawing to a digital file, you can then print the file on the materials of your choice. This feature can also be found on our app, BeamCam.

1. Place the artwork in the work area.

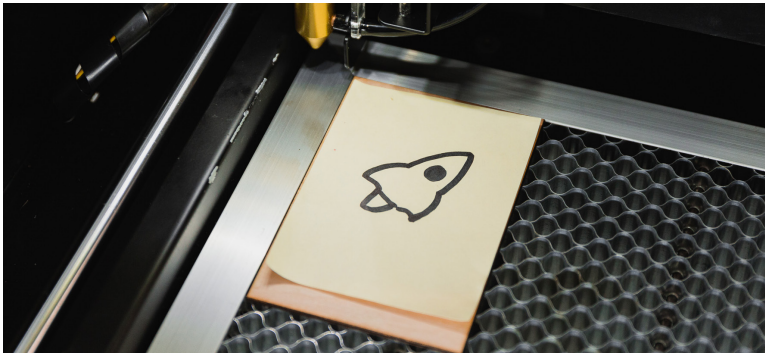

2. Use camera preview to take snapshots of the artwork.

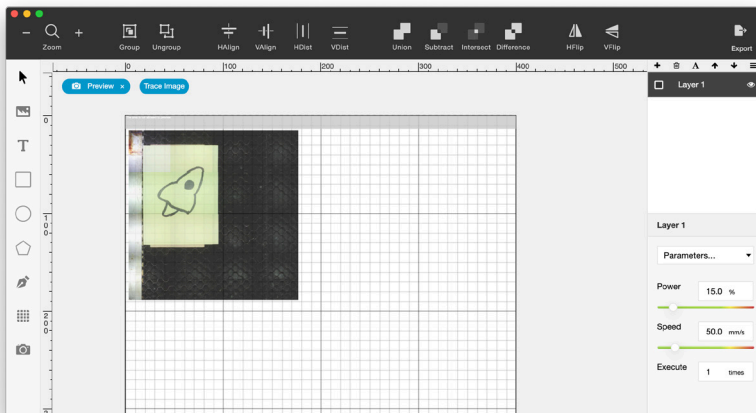

3. Click "Trace Image" and drag a square around the artwork that you want to trace. You'll see a preview of what your beamo will engrave. Anything in black will be engraved, and nothing else will be.

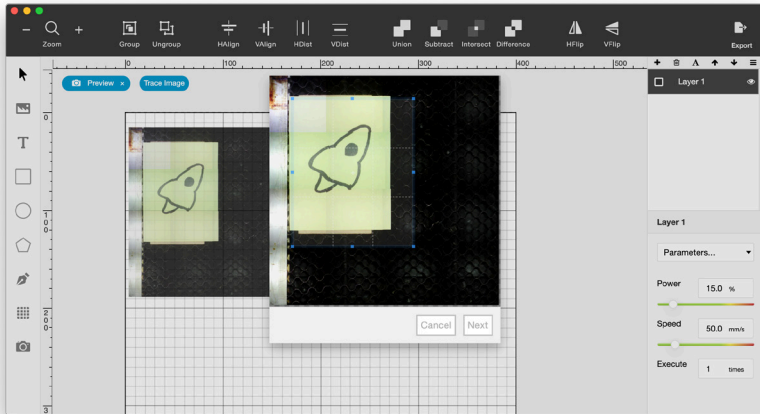

4. Darken or remove small details like dirt and noise by adjusting the exposure threshold value.

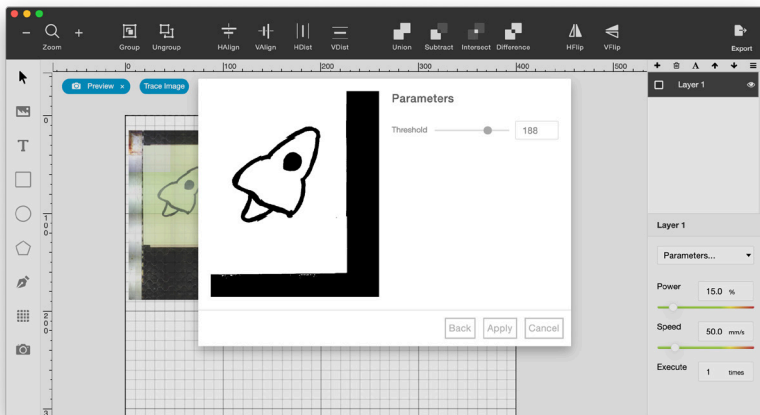

5. Click "Preview" and when your trace looks ready, click "Apply".

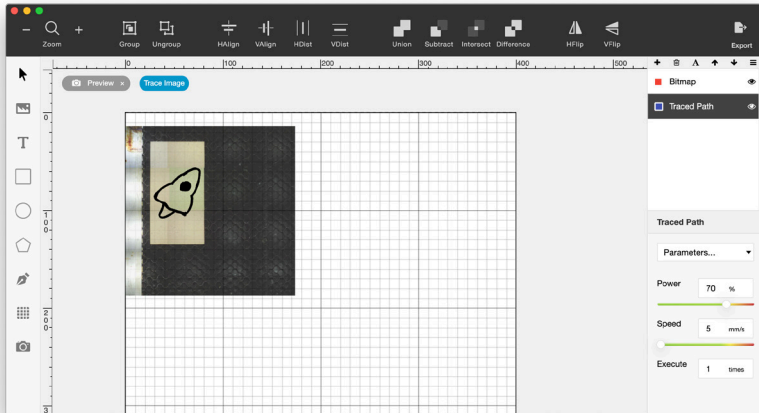

6. Set the power and speed and start the laser job. Prepare to see your newly digitized artwork!



**M A T
E R I
A L**

**T E C
H N I
Q U E**

4.1 TESTING NEW MATERIALS

To test different speed and power combinations on a new material, import the "Material Testing Suite" from the menu > File > Samples.

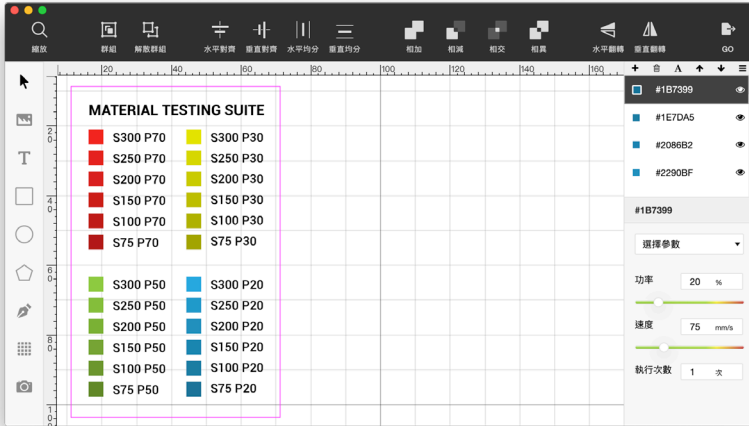

4.2 WOOD

Types of Wood

- **Medium-density Fiberboard (MDF)**

MDF is a wood product made by wood fibers and resin binder formed under high temperature and pressure. The resin binder has a significant effect on the fume generated during laser process. Low formaldehyde MDF is recommended to reduce harmful fumes.

- **Plywood**

Plywood is made by layers of wood veneer or wood fiber glued together. Low formaldehyde plywood is recommended to reduce harmful fumes.

- **Solid Wood**

Solid wood might have uneven grain when engraved due to growth rings. The uneven density of wood can cause such result which is very usual.

Engraving Results on Wood

The slower the speed, the darker the engraved result. The higher the power, the deeper the cutting depth. To achieve a darker effect, slowing down the speed is usually more useful than raising the power.

How To Prevent Burn Marks On Wood

Cover the surface with masking tape prior to printing, or remove the marks with sandpaper. The alternative is to slightly wet the wood, but it might cause bumps on the surface.

How To Reduce Burn Edge On Wood

Clean the edges with alcohol or soapy water, or choose wood with lower density, so the cutting speed can be faster, leaving lighter edge marks.

4.3 LEATHER

Types of Leather

- **Synthetic Leather**

The surface of the synthetic leather is mainly divided into two kinds of materials: PU (polyurethane) or PVC (polyvinyl chloride). If the leather is PVC, it is strongly not recommended for laser processing (see Dangerous Materials). When PU is not completely burned, hydrogen cyanide might be produced.

- **Genuine Leather**

In general, in order to increase the thickness and the increase the durability, the leather will be processed

by tanning, that is, the part of the leather which is similar to the non-woven material. The tanned layer will require a slower speed when cutting.

How To Prevent Burn Marks On Leather

Leather gets burnt and curled easily when processed by laser. Soaking the entire piece of leather in water before processing should help.

Ventilation Requirements for Leather

Since there are many amino groups and benzene rings in the leather protein composition, nitrogen oxides or aromatic compounds may be produced during combustion. If the leather is engraved or cut for a long time, the ventilation requirements should be much higher than wood or acrylic. It is recommended to use an air filter and discharge the air to a safer place.

4.4 ACRYLIC

Identifying Acrylic

Acrylic is also known as PMMA or plexiglass, the scientific name is polymethyl methacrylate. It is one of the few plastics that can be processed by laser. Before processing, it is important to distinguish whether it is acrylic or

other transparent plastic materials (i.e. PVC or PC) that are not suitable for laser processing. When processed on, the edges of the acrylic are sharp and clear. If you see yellowish burn marks, the material is not acrylic. However, no burn marks doesn't indicate that it is acrylic.

Scratches on Acrylic

Scratches can be removed with plastic polish.

How to Clean Cloudy Acrylic

It is recommended that the film should remain on the acrylic when processing, unless engraving greyscale images. You can use an alcohol swab to clean the acrylic. Note that too much may cause other surface defects.

4.5 PAPER

How to Reduce Burn Edge on Paper

When cutting paper, it is easy to produce yellowish carbonized burn edges. The use of universal clay or other low-viscosity substances can effectively remove the toner to a certain extent without damaging the surface of the paper.

Corrugated Cardboard

When cutting corrugated paper, the cardboard might catch on fire due to the misfocus on the downward layer. Spray the board with water to reduce the chance of burning.

4.6 GLASS

Glass cracks easily, so the laser power should not be too powerful. Choose thick glass materials for better flexibility.

4.7 METAL

Anodized Aluminum

Anodic treatment is a surface treatment that forms an oxide layer on the aluminum alloy. Through laser engraving, the surface oxide layer will be decomposed.

Stainless Steel (with coating or Hybrid Laser)

Stainless steel reflects most of the energy from a CO₂ laser due to its wavelength. So special oxidants are required to allow the stainless steel to oxidize and darken at relatively low temperatures and darken the color. Wear work gloves when applying the coating. If you're using Hybrid Laser, the laser can engrave on stainless steel

4.8 OTHER SAFE MATERIALS

Stone, cement, EVA foam, cotton, linen material, etc.

4.9 DANGEROUS MATERIALS

- **PVC**

PVC is a common material that cannot be laser processed. When burned, PVC produces HCl (hydrochloric acid gas) that will harm the lungs and corrode machine parts. When PVC is burned, it also produces highly carcinogens such as dioxin or polychlorinated biphenyls. PVC is often presented in the forms of sticker, film or transparent sheet.

- **ABS**

ABS is a common material that cannot be laser processed. ABS tends to burn “dirty”, producing A (acrylonitrile), B (butadiene), and S (styrene), which are carcinogens category 2B, 1 and 2B.

- **Plastics With Chlorine, Benzene, Ammonia, Fluorine, Phenol, Aldehyde in its Scientific Name or With A Hexagonal Benzene Ring in its Molecular Formula**

When burning plastic molecules with these elements or organic structures, the chances of producing carcinogens and toxic substances are extremely high. Laser processing is not recommended.

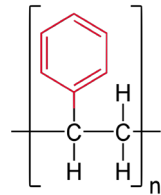

There should be no benzene ring in the ▲ molecule for the material to be laser-safe.

**P R O
J E C
T**

**I D
E A
S**

5.1 INSPIRATIONS



<https://pse.is/KFDPO>

- Pinterest Idea Board <https://pse.is/JXRR5>

💡 Search for "laser engraving" on Pinterest for more ideas!

- Ponoko Laser Engraving Ideas <https://pse.is/HQARL>

5.2 VECTOR FILES

- The Noun Projects <https://thenounproject.com/>
- Freepik <http://freepik.com/>

5.3 CUTTING FILES

- DXF Projects <https://dxfprojects.com/>
- Canon Creative Park <http://cp.c-ij.com/sc/index.html>
- Paper-replika <http://paper-replika.com/>

5.4 FREE FONTS

- Dafont <https://www.dafont.com/>

💡 To find conjoined words, check the category of calligraphy.

M A I N

T E N

A N C E

&

C A R E

6.1 KEEP EVERYTHING LUBRICATED

Clean and lubricate the guiding rods and rail periodically can extend the lifetime of the moving parts. The frequency recommended is once every 1 - 2 weeks.



1. Wipe away the oil grease on the guiding rods and rail using a paper towel.
2. Apply lubricant on the guiding rods of the Y axis.
3. Apply lubricant on the top and the side of the linear rail of the X axis.
4. Move the laser head up-and-down, left-and-right several times to evenly distribute the lubricant.

6.2 CLEANING OF THE WORKAREA

Remove leftover cutting and engraving bits from the workarea whenever there is a buildup. A buildup of leftover bits can create a fire hazard.

1. To remove the honeycomb plate, first move the laser head to the top left corner, lift the honeycomb plate slightly and slides it toward you.

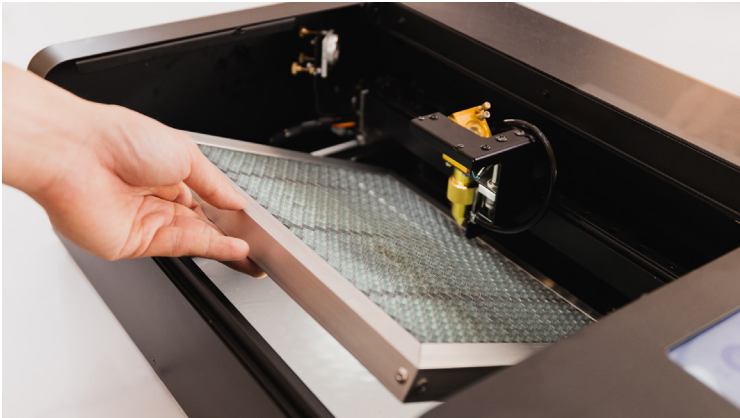

 Mind the sharpness of the plate surface to avoid cutting injury.

2. Use vacuum cleaner or brush to clean the leftovers bits under the plate. Detergent can be applied to remove the stains
3. Return the plate to the original location, sliding it in horizontally. Be careful not to contact the laser head or the rails.

6.3 WIPING THE LENS

After every 40 hours of working, use lens wipes or wet cotton swabs to clean the lens and mirrors. Do not rub the mirrors fiercely to prevent damage of the coating on the mirrors. This will keep the unit working properly and prevent permanent damage to your unit.

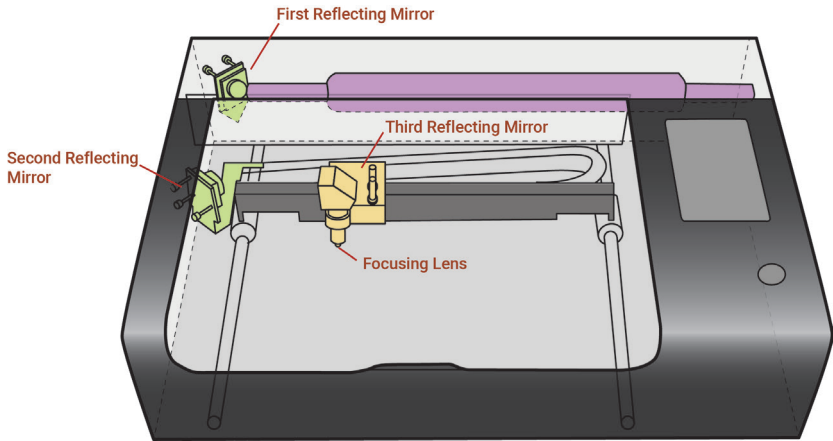

1. Clean the three reflecting mirrors.



The focus lens is inside the lens holder under the third reflecting mirror. Lower down the honeycomb plate or remove it to make room for later procedure. Rotate the lens holder ring clockwise to release and remove the lens holder.



▲ release and remove the lens holder

Rotate the silver ring on the lens holder counter-clockwise to take out the focus lens. Use pliers if the ring is too tight to rotate.



When putting back the lens, the curved side should face up and the flat side should face down.

6.4 WATER COOLER MAINTENANCE

Adding Water

When you see a low water level or a "#900 Cooler Off" dialog appears on the touchscreen. Please add water to the water tank.

1. Unplug the machine.
2. Remove the back lid by unscrewing the 6 star screws with the hex key in the Accessory Kit.

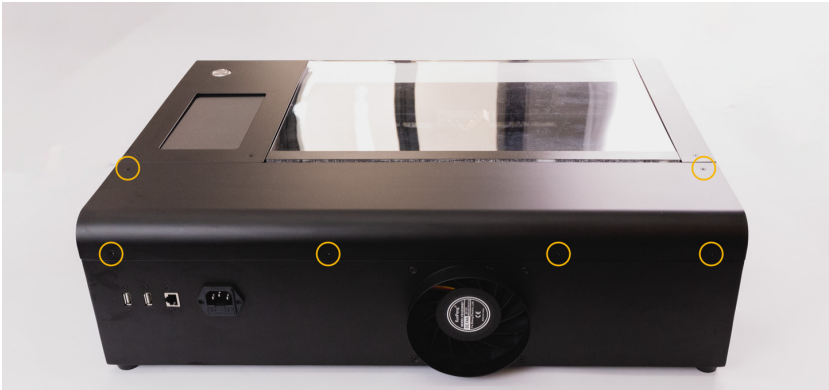

3. Open the water tank with the small wrench.

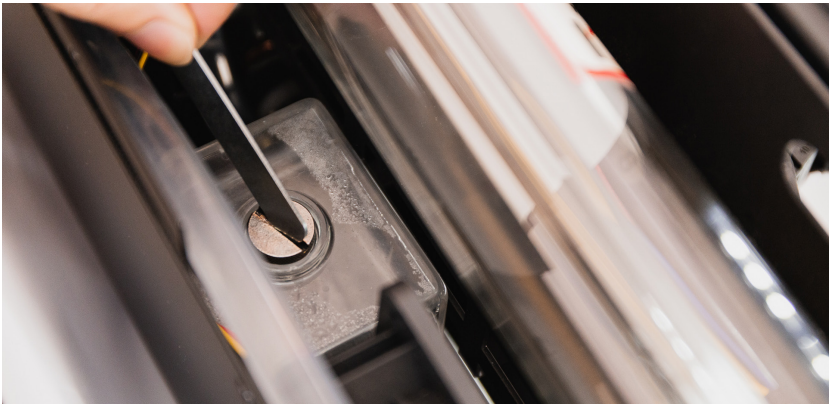

4. Fill up the tank using distilled water. Watch the water level carefully to prevent from spilling over. Seal the tank when the water level reaches 80% full.



Changing Water

It is recommended that the water should be changed once every 3 months.

1. Repeat Step 1 and 2 of "Adding Water".
2. Remove the hose clamp with pliers and pull apart the hose from the white connector of the flow sensor. Place the two ends of the hose into a container to prevent water from spilling out.

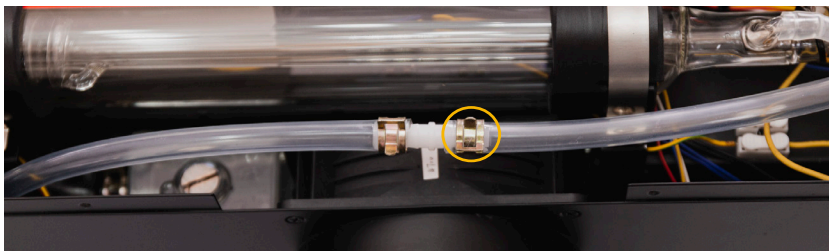

3. Remove the laser head, plug the air outlet into the water pipe. Go to touchscreen and press **Action > Air Pump**, the water will be blown out from the other end. Press "Air Pump" again when water is drained from the water tank and hose.



4. Repeat Step 3 and 4 of "Adding Water".
5. Restart the machine. Go to touchscreen and press **Action > Air Pump**. The water in the tank will be pushed into the cooling system. Repeat Step 4 until the water level no longer decreases.

⚠ Excessive bubbles in the laser tube may decrease the cooling efficiency. It is recommended to fill the water tank more than 80% to decrease bubble generation.

6.5 OPTICAL PATH ALIGNMENT

If the workpiece cannot be cut through by the preset parameters or the beam output varies significantly on each corner of the work area, the optical path might be misaligned and needs adjustment.

Tools

Accessory Kit: ② hex key ③ small wrench ④ tape

Prepare On Your Own: ① 2.5mm Allen key



Safety Precautions

1. Keep the lid shut when pressing "Laser Pulse".
2. If you hear a loud cracking sound, stop operating and shut down the power immediately. Contact FLUX Support.

Remove the back lid by unscrewing the 6 star screws with the hex key in the Accessory Kit.

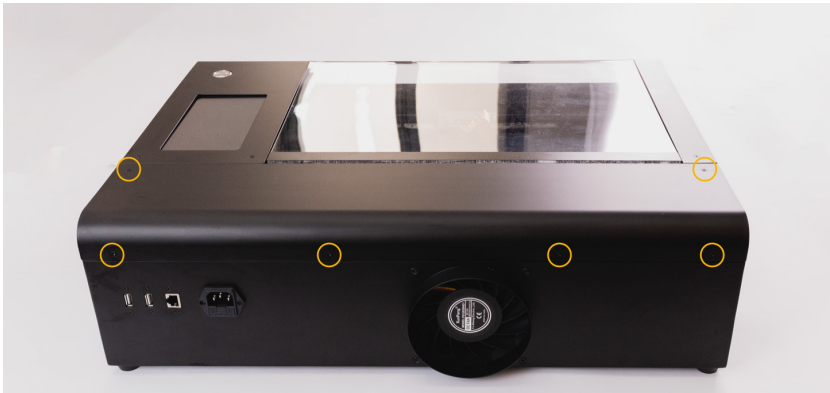

There are three sets of reflecting mirrors and one set of focusing lens in beamo.

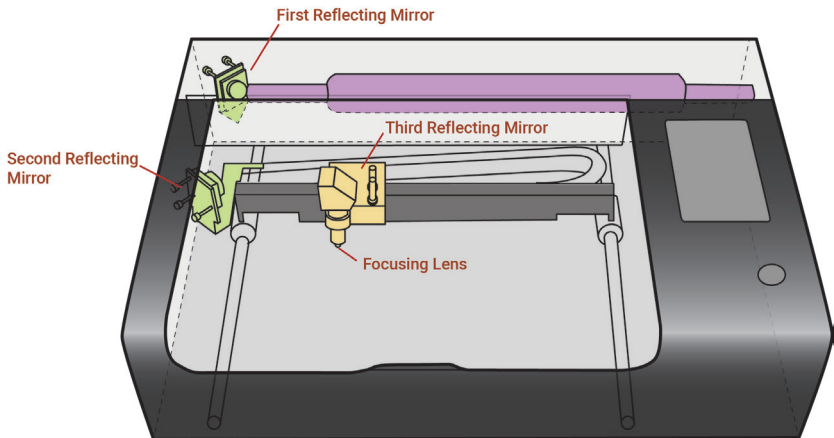

- First reflecting mirror is located on the left side of the laser tube when facing the machine.
- Second reflecting mirror is located on the carriage of the guiding rod on the left side when facing the the machine.

- Third reflecting mirror is located on the rail of the X-axis.
- Focusing lens is located inside the lens holder underneath the third mirror.

First Reflecting Mirror

Goal: Make the 2 dots shot from the top-left and the bottom-left overlap.

1. Go to touchscreen > Maintain, the laser head will go back to home position. Then press "Release Motors".
2. Put a piece of tape over the second reflecting mirror.

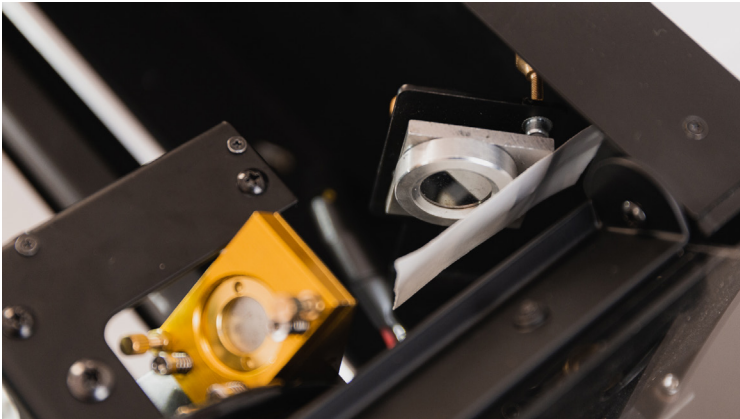

3. Move the laser head to the top-left position manually. Close the lid and press "Laser Pulse".
4. Open the door and check the position of the dot. This dot is the reference point for adjustment. The shots made on other positions should be adjusted to move toward the reference point.



5. Manually move the laser head to the bottom-left.
6. Close the lid and press "Laser Pulse".
7. Open the door and check if the second beam is overlapping with the first one. If not, adjust the screws behind the first mirror.

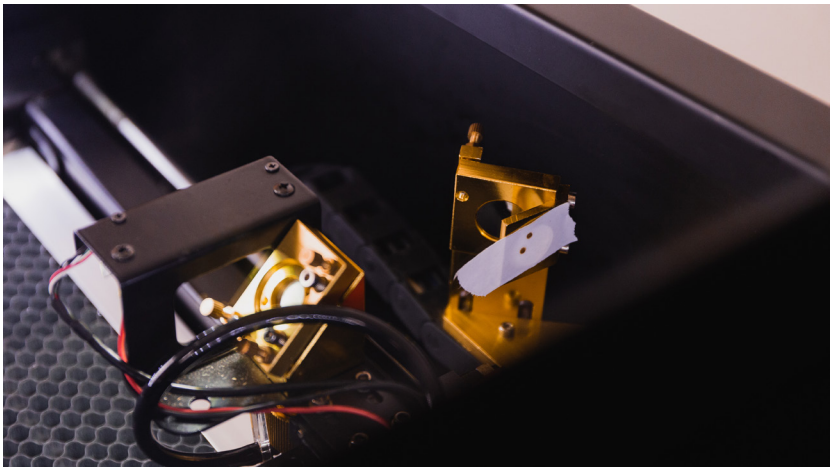

 If the dot shot from the bottom left corner is not found on the tape, it means the optical path is very much misaligned. Try the mid-left position instead of the bottom-

left position. Make sure the dots of the top-left and the middle-left overlaps, then go back to the original top-left and bottom-left adjustment.

8. The screws behind the first mirror control the mirror angle shown in the picture below. Release the nut on the screw, rotate the screw for the desired direction and test the dot position until the two dot overlaps. Tighten the nut slightly back to its position when the adjustment is done.

first mirror



dot direction

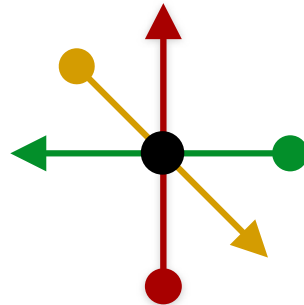

Adjustment guide for the screws of the mirror:
Shots made on the reference point (top-left in this case) rarely moves when adjusting the screws. So try to adjust the shot on the adjustable point (bottom-left in this case) by the screws and move the point toward the reference point until they overlap.

Second Reflecting Mirror

Goal: Make the 2 dots shot from the middle-left and the middle-right overlap.

1. Put a piece of tape on the metal ring of the third mirror.

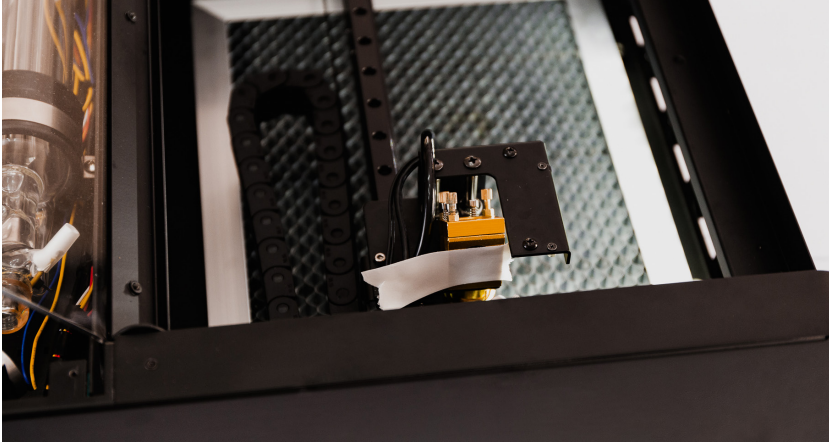

2. Move the laser head to the mid-left position manually. Close the lid and press "Laser Pulse".
3. Open the door and check the position of the dot. This dot is the reference point for adjustment. The shots made on other positions should be adjusted to move toward the reference point.

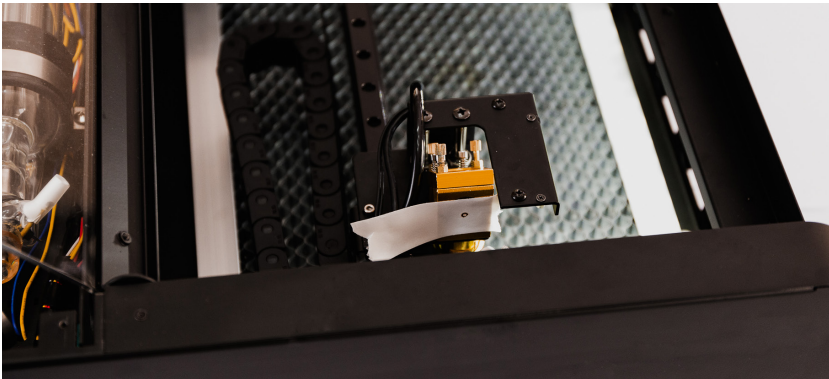

4. Move the laser head to the middle-right position manually. Close the lid and press "Laser Pulse".
5. Open the lid and check if the second dot overlaps with the first one. If not, adjust the screws behind the second mirror.

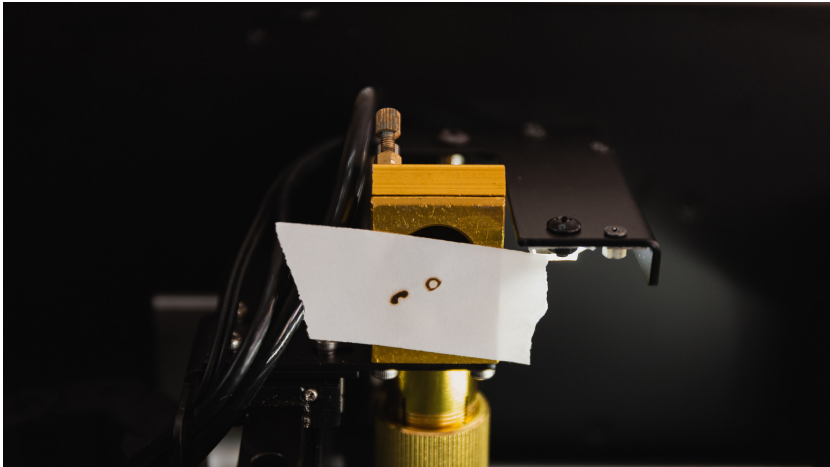

⚠ If the dot shot from the middle-right corner is not found on the tape, it means the optical path is very much misaligned. Try the middle-middle position instead of the middle-right position. Make sure the shots of the middle-left and the middle-middle overlaps then go back to the original middle-left and middle-right adjustment.

- The screws behind the second mirror control the mirror angle shown in the picture below. Release the nut on the screw, rotate the screw for the desired direction and test the shot position until the two shots overlaps. Tighten the nut slightly back to its position when the adjustment is done.

second mirror



dot direction

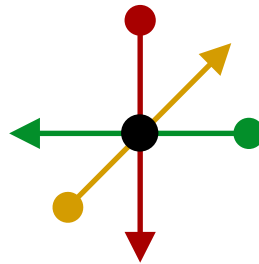

Laser Head Displacement Adjustment

Goal: The dot on the metal ring be on the vertical center line of the ring. The dot must be above the center point of the ring.

- Move the laser head to the center of the workarea
Close the door and press "Laser Pulse".
- Check if the dot landed on the vertical center line of the ring. If yes, skip to Step 6.

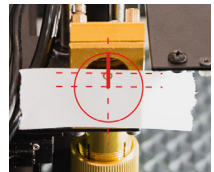

3. Release the 4 hex socket head screws with a 2.5mm Allen key.
4. Move the laser head forward or backward related to the rail. Then tighten the 4 screws back.
5. Press "Laser Pulse" and check if the dot landed on the vertical center line of the ring. If not, repeat the Step 3 and 4.
6. Check if the dot overlaps or is above the horizontal center line of the ring. If yes, move on to "Third Mirror Adjustment".

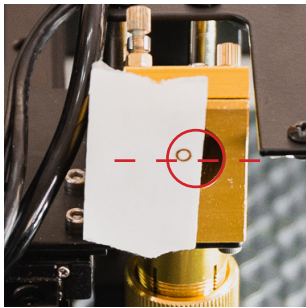

▲ above center

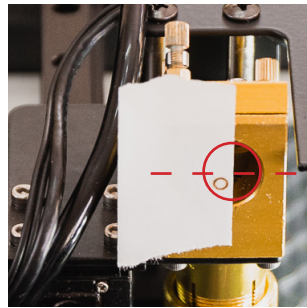

▲ below center

7. If the dot is below the center line, adjust the screws of the laser tube holder. Release the holder on the laser beam outlet side and tighten the other side.



▲ tighten

▲ loosen

8. Check if the dot overlaps or lands above the center line. The first and second mirrors might require readjustments if the position of the laser tube holder is widely adjusted.

Third Reflecting Mirror

Goal: Dot be made on the center of the laser beam outlet.

1. Lower the honeycomb plate to make room for adjustments.
2. Place a piece of tape on the laser head outlet. Apply pressure to the tape by hand so a circular mark can be seen.

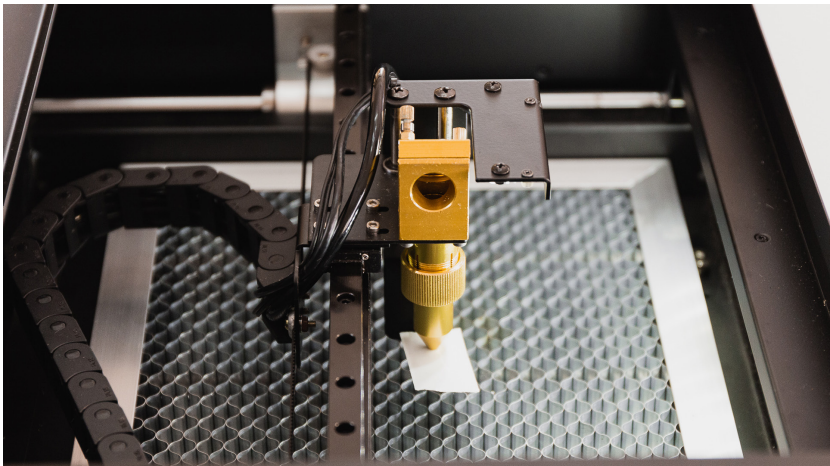

3. Move the laser head to the center of the workarea manually. Close the door and press "Laser Pulse".
4. Open the door and check if the dot is located near the center of the circle. If not, the screws behind the

third mirror need to be adjusted.

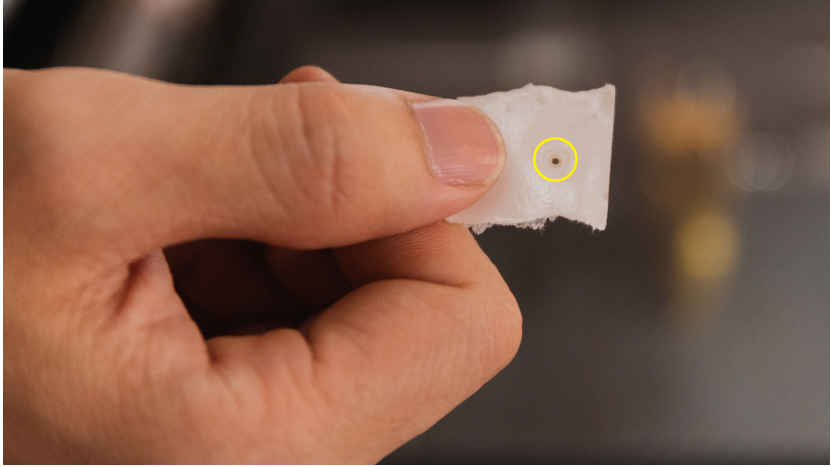

5. The screws behind the third mirror control the mirror angle which is shown in the picture below. Release the nut on the screws, rotate the screws for the desired direction until the two dots overlap. Tighten the nut slightly back to its position when the adjustment is done.

Third Mirror



Dot Direction

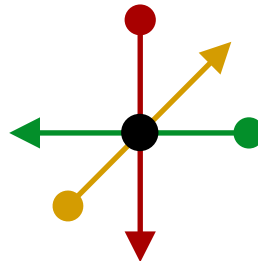

The power of the laser can now be distributed evenly to any spot of the workarea after the adjustments above. The performance should meet the needs of regular operation. Make sure you run "Camera Calibration" again after the optical adjustment. If the verticality of the optical path is required in specific applications, then steps below can be carried out for advanced adjustments.

Verticality of the Optical Path (Advanced)

Goal: Both dots on the lens holder and the laser beam outlet be on the center of the circle.

1. Move the laser head to the center of workarea manually. Place a piece tape on the metal ring in front of the third reflecting mirror.
2. Close the door and press "Laser Pulse".
3. Open the door and measure the distance between the center of the dot and the center of the ring. Let the distance be X .



4. Release three nuts behind the third mirror. Rotate the three screw equally so the mirror can move forward or backward in a paralleled direction. Make the gap between the metal pieces be X mm.

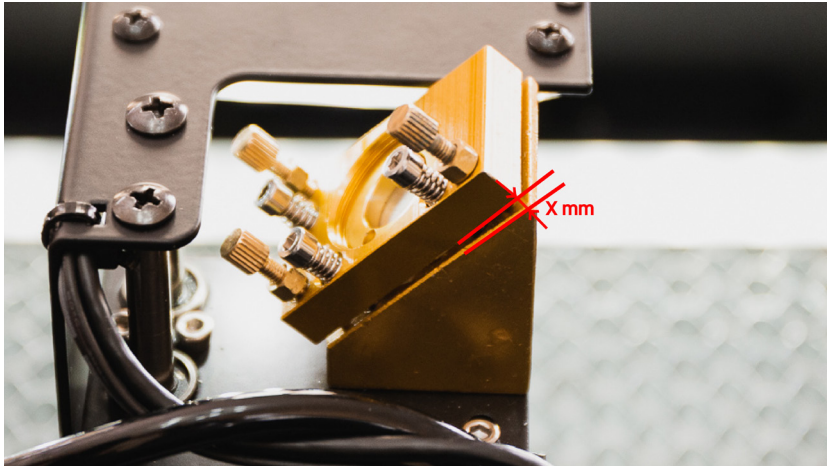

5. Release the lens holder ring by rotating clockwise and lowering the lens holder to the mid-height. Fasten the holder by rotating the ring counter-clockwise.
6. Place a piece of tape to the beam outlet.
7. Refer to the steps of "Third Reflecting Mirror" and readjust the screws behind the third mirror so the dot lands on the center of the circle.
8. Release and remove the whole lens holder. Place a piece of tape on the location shown in the picture below. Apply pressure to make a circular mark on the tape.

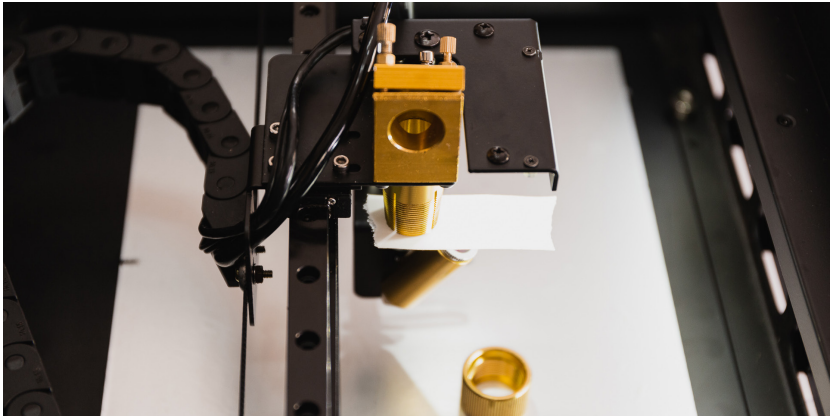

9. Close the door and press "Laser Pulse". Open the door and check the dot. There are three scenarios:
- The shot is in the center of the circle. Indicating the optical path is already vertical.
 - The dot is on the right side of the circle. Indicating the optical path has an angle which comes from the top-right and exit to the bottom-left. Release the each screws counter-clockwise half-round to decrease the gap distance between the metal pieces. Redo Step 5 - 9.
 - The dot is on the left side of the circle. Indicating the optical path has an angle which comes from the top-left and exit to the bottom-right. Tighten each screws clockwise half-round to increase the gap distance between the metal pieces. Redo Step 5 - 9.

Make sure you run "Camera Calibration" again after the adjustment is done.

6.6 LASER TUBE REPLACEMENT

Tools

Accessory Kit: ① little wrench ② funnel

Laser Tube Box: ⑧ laser tube hose plug ⑥ cable ties

Prepare On Your Own: ③ Philips screw driver ⑤ diagonal pliers ④ needle-nose pliers ⑩ water container ⑨ towel



 Unplug power before operation.

1. Remove the back lid by unscrewing the 6 star screws with the hex key in the Accessory Kit.

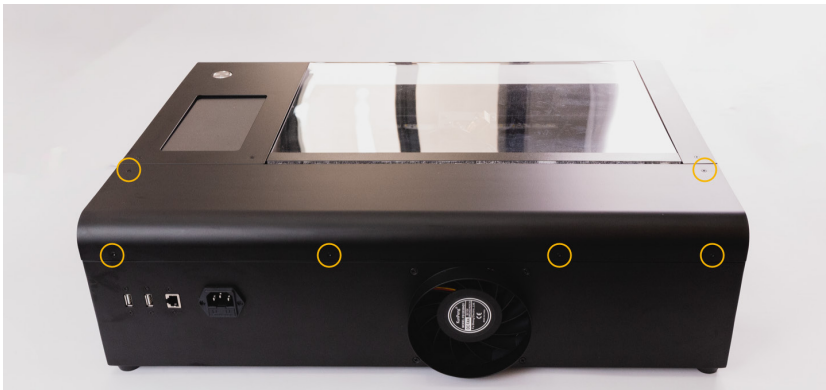

There are two ends on a laser tube. The one with the red wire which is closer to the touch screen is called the high-voltage side. The other next to the first mirror is called the low voltage side.

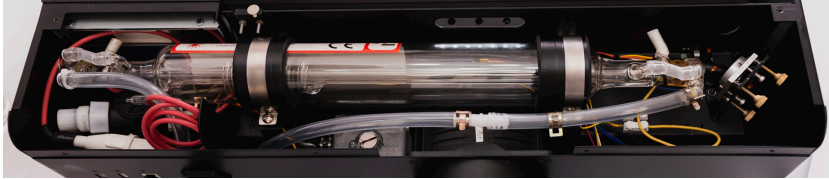

▲ high-voltage

▲ low-voltage

2. Find the white connector on the high-voltage side. Twist open the connector and disconnect it.

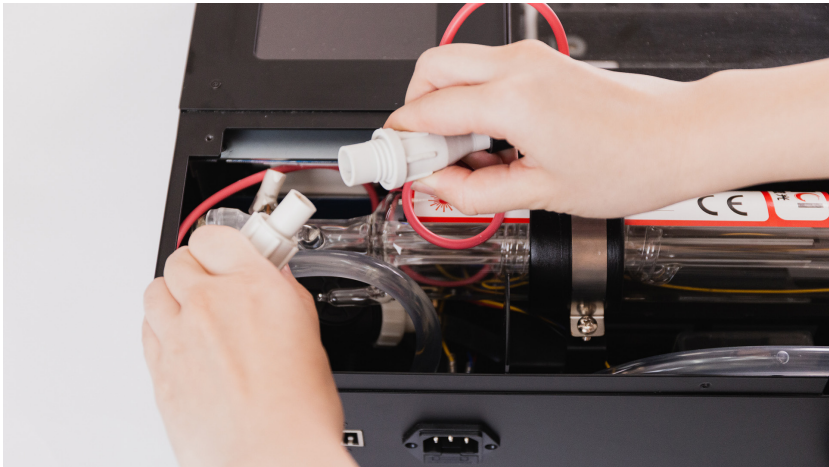

3. Find the white terminal near the low-voltage side. Press the button on the white terminal to release and remove the cable connected to the low voltage

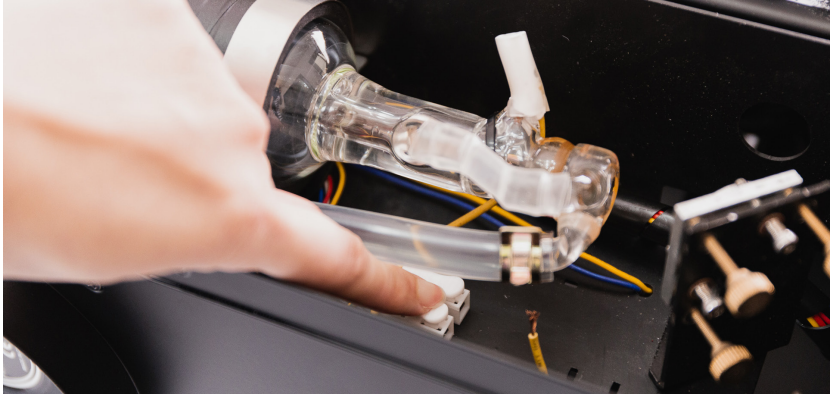

4. Remove the screws of the tube holder on both sides.

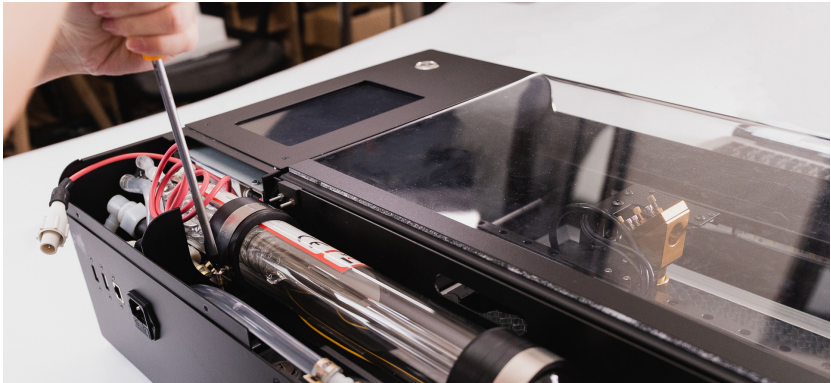

5. Use pliers to move the hose clamp away from the laser tube.

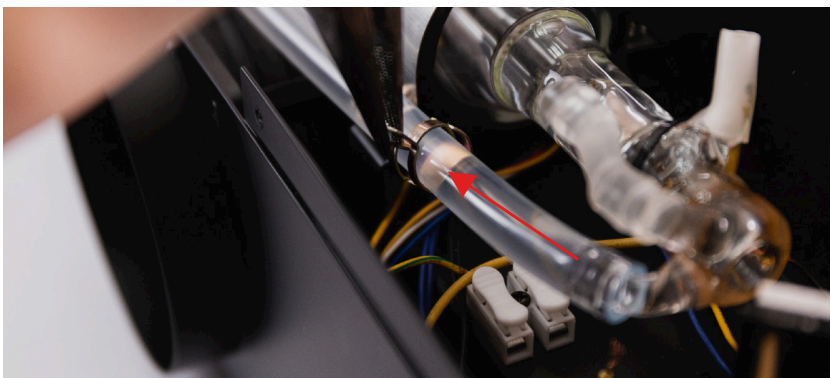

6. Take the laser tube out of the chassis and place the low-voltage side above a container.



7. Disconnect the hose from the tube and drain the water. Clog the hose by a plug when done.



8. Place a towel on the high-voltage side.



9. Cut the cable tie on the end of the hose with diagonal pliers or scissors.



10. Pull off the hose and clog the end.



 Avoid spilling water into the machine. If it happens, wipe away the moisture and wait till the machine entirely dries up before operating.

11. The laser tube is now fully disconnected and can be entirely removed.



12. Place the new laser tube and connect the hoses on both ends.



13. Zip the high-voltage end by a cable tie and clamp the other end using the original metal hose clamp.



▲ Zip the high-voltage end by a cable tie

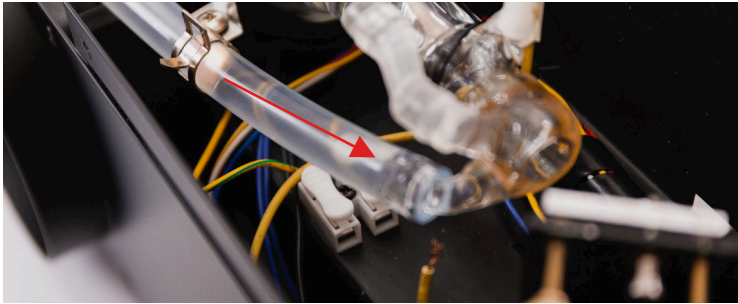

▲ clamp the low-voltage end using the original metal hose clamp

⚠ Release the metal clamp slowly to prevent the reaction force from damaging the laser tube.

14. Reconnect the white connector on the high-voltage side. Plug in the wire to the terminal on the low-voltage side and make sure the wire get clamped firmly and does not fell off. Check the wire if firmly clamped by the terminal.

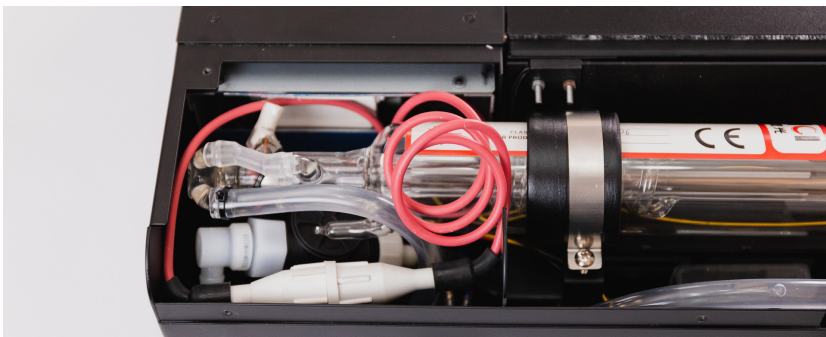

▲ reconnect the white connector on the high-voltage side.

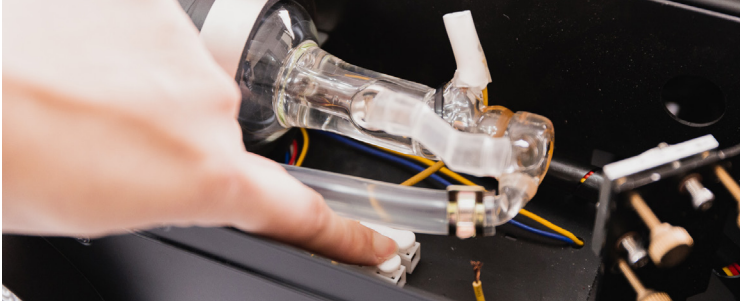

▲ check the wire if firmly clamped by the terminal

14. Place the laser tube into the chassis. Make sure the gap is wider than a finger on both ends of the tube. The terminal on the laser tube which connected to the thick red wire should point upward. Install the screws of the tube holder clip and make sure the tube is fastened firmly.

⚠ Make sure the terminal of the red cable points upward instead of another angle. Do not let the end of the tube touch or close to the side of the chassis. Wrong placement for the tube may cause voltage leak.



15. Make sure everything is properly installed. Turn on the machine when ready.

 Do not touch the area near the high voltage side on the tube to prevent electric shock.

16. Press "Maintain" and the laser head will go to home position. Press "Pump" and the cooling water will be pumped into the laser tube.

 Beware not to press "Laser". Do not put finger near the laser beam outlet.

17. Unplug power and open the cap of the water tank with the small wrench. Fill the tank with a funnel and seal it back.

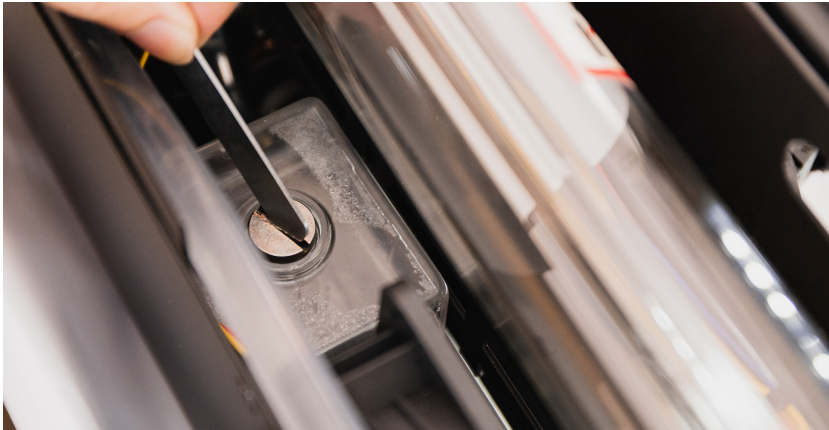

▲ Use the little wrench to open the tank.



▲ use the little wrench to open the tank

18. Repeat Step 11 and 12 until the level of the tank no longer goes down. Then the replacement is complete.

**T R O
U B L
E S H
O O T
I N G**

7.1 NO LASER BEAM OUTPUT

If there is no laser beam output when beamo is running and making a loud cracking sound, it indicates the tube is broken. Please stop operating the machine to prevent further hardware failure.

If you do not hear the cracking sound, please check the following:

1. Go to touchscreen > Maintain, make sure the power is set to "x1.0" then close the door. Press "Laser Pulse" and observe from the laser observe hole if a pinkish fluorescent light is emitted. If yes, it means the laser tube is functioning, please proceed to checking the optical path. If no pinkish fluorescent light is observed, please contact FLUX Support.



7.2 CUT DIDN'T GO THROUGH MATERIAL

1. Go to touchscreen > Maintain, make sure power is set to "x1.0".
2. Check if the focus is adjusted at the right height.
3. Check if the lens or mirrors are dirty or damaged.
4. Check if the optical path is aligned.
5. If the solutions above didn't work, please contact FLUX Support.

7.3 #900 COOLER OFF

1. If you see a "#900 Cooler Off" dialog appears on the touchscreen, press "Continue". If the error message did not pop up again within one minute, the machine should operate normally.
2. Check if the water level of the cooling tank is at least half full.

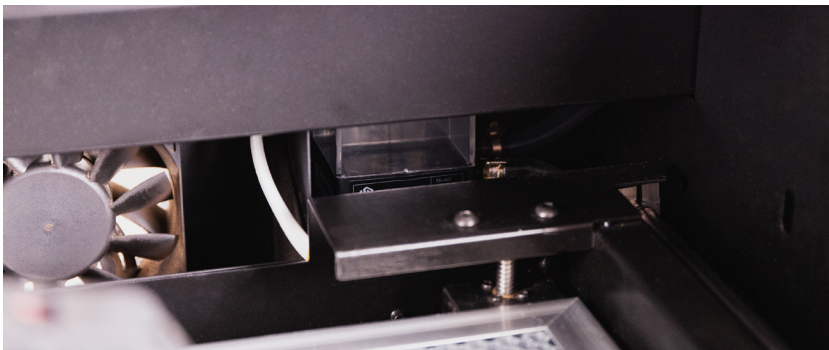

7.4 #901 DOOR OPENED

 If the base is detached, install the base back first.

1. Go to touchscreen > Maintain, observe the icon on the top right corner. Check if the door icon is changed to "closed" when the front door is closed. If the icon is changed, the machine should operate normally.

 : Door opened  : Door closed

2. If the icon didn't change, please check if the door magnet fell off.

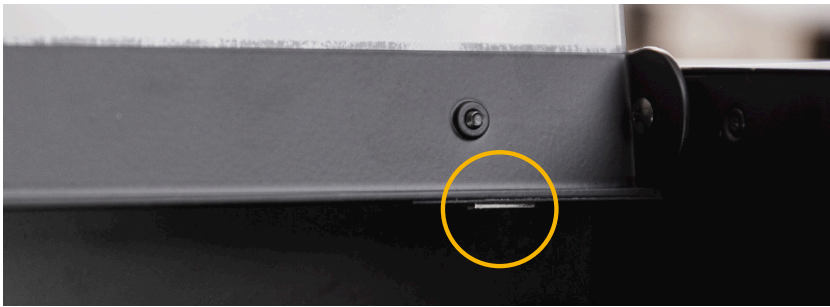

3. If the magnet is still in place, open the back lid, take a magnet and place it over the sensor.

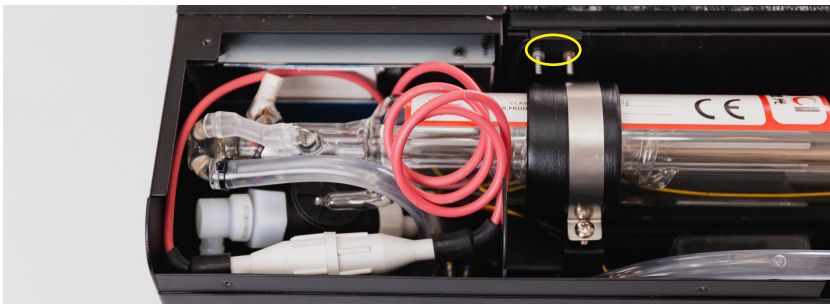

7.5 #902 OVERHEATED

1. Check if the room temperature is 5°C- 35°C (41°F - 95°F).
2. Go to touchscreen > Maintain, and check if the temperature is 5°C- 35°C (41°F - 95°F).
3. If there is a huge difference between the room temperature and the temperature shown on the touch screen, please contact FLUX Support.

7.6 THE LASER HEAD DOESN'T RETURN TO REAR LEFT CORNER

1. Gently move the laser head to the center of the bed.



2. Go to touchscreen > Maintain, the laser head should first move to the top and then move to the rear left.

3. If the laser head doesn't return to the rear left corner, please use your phone or camera to make a video including the whole work area (like the image in Step 1).
4. Start filming and repeat Step 1 and 2, send the video to FLUX Support.

7.7 CAMERA ALIGNMENT ISSUE

1. Run camera calibration in software: **Beam Studio > Menu > Machines > Choose Machine > Calibrate Camera**. Make sure the height of the laser head is adjusted to the right focus.
2. Compare the red-dotted-line square with the actual square engraved, manually adjust the values to make the 2 squares overlap.

7.8 CAMERA PREVIEW SPEED TOO SLOW

The preview results are formed by multiple snapshots put together, if the loading speed is too slow, improving the internet connection might help.

1. Go to software: **Beam Studio > Menu > Machines > Test Network Settings**.
2. Fill in the Target device IP Address column with the machine IP address.

3. Press Start and the test will start running.
4. If the average response time is over 100ms, try reducing the distance between the machine and the router or mobile hotspot, or change to a wired connection.

7.9 CAMERA PREVIEW DOESN'T WORK

If camera preview can't be activated, please try the following:

1. Restart the machine and press "Maintain" and wait for the laser head to go to home position.
2. Use the arrow keys or manually move the laser head to the center of the bed.
3. Press Snapshot, if the image is shown, it means the camera is functioning. Please refer to 7.8 Camera Preview Speed Is Too Slow (p.89).
4. If you see a question mark icon, it means the camera is not functioning. Please contact FLUX Support.

7.10 CONNECTION ISSUE

No Wi-Fi Found

1. Make sure the Wi-Fi dongle is fully plugged in.
2. If there is no MAC Address of the wireless network on the touchscreen, please contact FLUX Support.

3. The Wi-Fi channel should be 2.4Ghz (5Ghz is not supported).

Unable to Connect When Selecting Wi-Fi

1. The Wi-Fi encryption mode should be WPA2 or no password.
2. The encryption mode can be set in the Wi-Fi router administration interface. If the router doesn't support WPA2 and you need help picking out the right router, please contact FLUX Support.

Machine Doesn't Appear In The Software

1. Go to touchscreen > **Settings** > **Internet** and confirm the machine IP address. If the IP address starts with 169.154, please see "IP Address Starts With 169.154" (p.0000000)
2. Go to software **Beam Studio** > **Menu** > **Beam Studio** > **Preferences**, and fill out the Machine IP Address column.
3. If the machine doesn't appear, please see "Confirm Connection".

Confirm Connection

Make sure the machine IP address is shown and doesn't start with 169.154.

1. Go to software Beam Studio > Menu > Machines > Test Network Settings

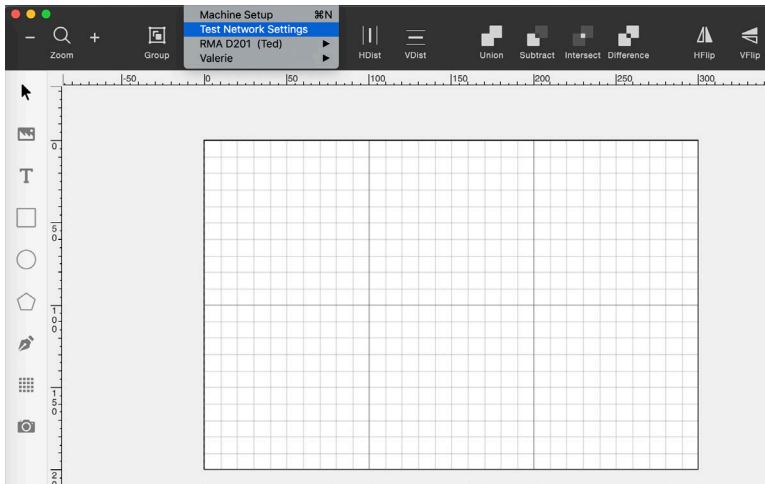

2. Fill in the Target device IP Address column with the machine IP address.

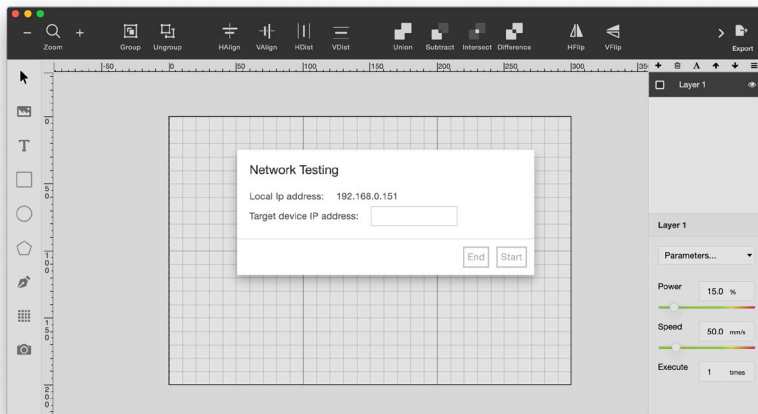

3. Press Start and the test will start running.

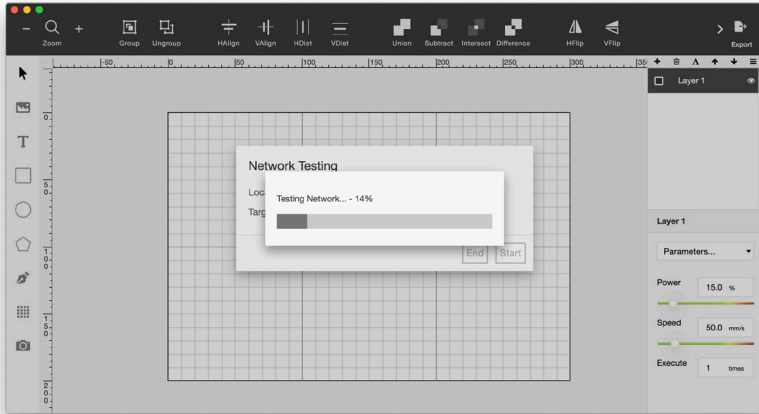

4. The statistics include Network Healthiness and Average Response Time. The Network Healthiness should be >95%, the Average Response Time should be <100ms. If the machine IP address is keyed in but the machine is still not found, please update the software to the latest version. If the connection issue persists, please contact FLUX Support.

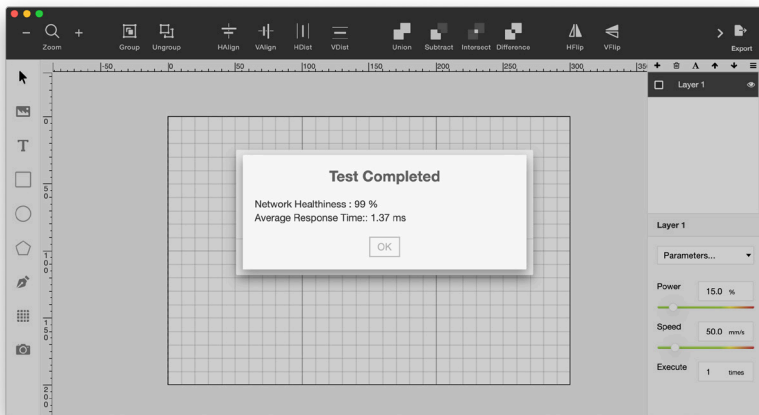

IP Address Starts With 169.154

1. If the IP address starts with 169.154, it should be a DHCP setting issue, please contact your ISP (internet service provider) for further assistance.
2. If your computer connects to the internet directly using PPPoE, please change to using the router to connect using PPPoE, and enable DHCP feature in the router.

7.11 SOFTWARE QUILTS UNEXPECTEDLY

- **Windows**

Please install Visual C++ Redistributable 2015, if the latest version is installed, please download the latest Visual C++ Redistributable 2015 - 2019. If you are using Windows 7, please update to Windows 7 SP1, install the latest graphics driver and Windows Update KB2670838.

- **macOS**

Please update your OS to macOS 10.14 (Mojave) or above. Previous OS versions might have compatibility issues.

- **Linux**

Due to numerous types of systems, please provide the software log to FLUX Support.

**A D D
I T I O
N A L**

**I N F
O R
M A T
I O N**

8.1 TECHNICAL DATA

Dimensions

W/D/H 615 x 445 x 177 mm (24.2 x 17.5 x 6.9 inches)

Weight 22 kg (48.5 pounds)

Mechanics

Working area 300 x 210 x 45 mm (11.8 x 8.2 x 1.7 inches)

Camera HD CMOS

Laser

Power 30W

Wavelength 10640 nm

8.2 STORAGE & TRANSPORT

Please keep the original packaging and upholstery.

- If your beamo remains unused for a short period of time, we recommend covering it to protect it from dust and other pollution.
- To store your beamo for a long period of time, it must be packed in its original packaging and not be exposed to high temperature and humidity fluctuations.
- beamo must be transported and shipped in its original packaging and original upholstery. beamo must not be thrown, knocked, shaken or subjected to any other mechanical loads.

8.3 FLUX SUPPORT

If you need help resolving a problem, feel free to contact FLUX Support by email: support@flux3dp.com. Please read the User Manual completely and install the latest software and firmware update before contacting customer support.

8.4 DISASSEMBLING & DISMANTLING

beamo can be disposed of as a complete device. You do not have to disassemble or dismantle the unit before disposal. Only the cables and ventilation hoses can be handed over separately from your beamo to the electrical equipment collection unit. If disassembling or dismantling of the device is required, please contact FLUX. As described in 1.3 Safety & Conformity, the user is not intended to disassemble beamo.

Disposal, environmental considerations

beamo may not be disposed of with household wastes in accordance with local laws and regulations. Your beamo is an electronic device and must be disposed of in accordance with the Electrical and Electronic Equipment Waste Directive of your country at local electrical and electronic equipment waste collection points. For further questions, please contact FLUX.